

# Changing the Focus to Recovery: What Would It Look Like and How Could We Do It?



ED JOHNSON, M. ED, MAC, LPC  
THE CAROLINAS & KENTUCKY PROGRAM MANAGER  
SOUTHEAST ADDICTION TECHNOLOGY TRANSFER CENTER  
(SOUTHEAST ATTC)

[WWW.ATTCNETWORK.ORG/SOUTHEAST](http://WWW.ATTCNETWORK.ORG/SOUTHEAST)

EDJOHNSON@MSM.EDU

# Course Objectives



## Participants will :

- Discover the changing environment that has propelled a “recovery movement.”
- Increase understanding of how changing the focus to recovery involves changing community norms and involves community mobilization.
- Demonstrate understanding of addiction as a chronic disease
- Learn how recovery principles can be infused into service design and delivery.
- Increase understanding of the role of language in perpetuating stigma with Substance Use Disorders
- Examine the Concepts of the Recovery Management Model, Recovery Capital and Peer Delivered Recovery Support Service.

# Starting Point



- A public amends
- Creating a recovery oriented system of care and implementing recovery management strategies will require a systems transformation
  - This will take time
- We are challenged to examine and evaluate our attitudes and beliefs towards those we serve and how we serve them
- We are challenged to view “prevention” in broader terms

If you have some respect for people as they are, you can be more effective in helping them to become better than they are

John W. Gardner

# Driving this Paradigm Shift



1. A loss of recovery focus through professionalization
2. Science-based conceptualizations of addiction as a chronic disorder (Hser et al., 1997; McLellan et al., 2000; Dennis & Scott, 2007)
3. Accumulation of systems performance data on limitations of acute care (AC) model of addiction treatment (White, 2008)

# Addiction as a Chronic Illness



- Should addiction be considered a chronic illness, similar to hypertension, diabetes, or asthma?
  - McLellan, A. T., Lewis, D. C., O'Brien, C. P., & Kleber, H. D. (2000). Drug Dependence, a Chronic Medical Illness: Implications for Treatment, Insurance and Outcomes Evaluation. *Journal of the American Medical Association*, (284)13, 1689 – 1695.

# Addiction as a Chronic Illness



- Clinical populations:
  - Higher personal vulnerability (e.g., family history, lower age of onset, victimization)
  - Higher problem severity (acuity & chronicity)
  - Higher rates of co-morbidity
  - Greater personal and environmental obstacles to recovery
  - Lower recovery capital (personal assets / family and social supports)

# Addiction and Recovery Careers



- Dennis et al. (2005) conducted a large study with 1,271 participants recruited from different agencies in west side of Chicago between 1996 and 1998



# Addiction and Treatment Careers



- The purpose of this study was to estimate the duration and correlates of years between:
  - First use and at least a year of recovery
  - First treatment admission and at least one year of recovery

# Addiction and Treatment Careers



- Achieving one year of recovery
  - Years from first use to last use
    - ✦ The median time was 27 years
  - Years from first treatment attempt to last use
    - ✦ The median time was 9 years (range 4 – 18)
  - Number of treatment episodes
    - ✦ The median number of treatment episodes was 3 - 4

# Addiction "Career"

**Number of abstinent periods one month or longer followed by return to drug use prior to current abstinence\***

**Two  
22%**

**One  
17%**

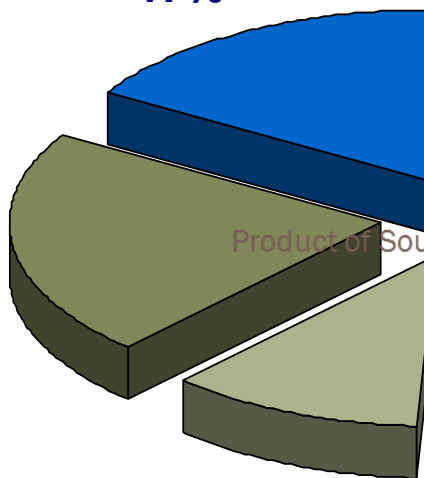

**Three  
11%**

**50% reported 4 or more abstinent periods followed by a return to active addiction**

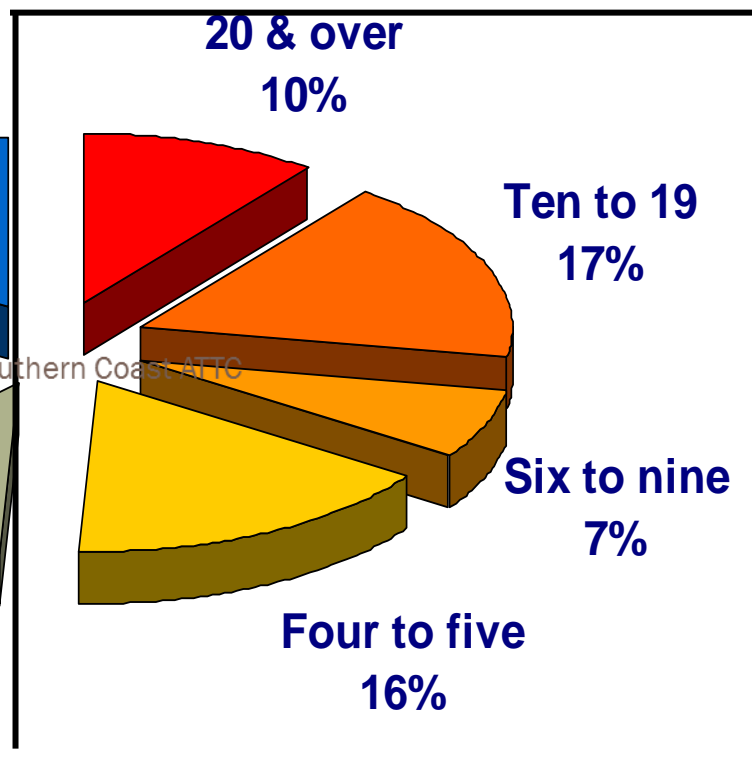

\*Outside of controlled environment, among those who report one or more such periods: **71% N=248** Laudet & White 2004

# Implications



- Most persons who develop a substance use disorder have substance related problems for years

# Why Focus on Recovery?



Expanding research base  
showing improved  
effectiveness of treatments  
and natural supports



Expectations of consumers  
and people in recovery

# Research Contributes to a Sense of Urgency

- Research shows that the systemic burden of untreated substance use disorder is costly – to individuals, families and society
- Scientific advances over the past 20 years have:
  - shown that addiction is a chronic, reoccurring disease that results from the prolonged effects of drugs on the brain
  - produced a multitude of evidence-based psychosocial therapies for substance use and mental health disorders
- Emerging *science of recovery* complements the science of addiction, leading to more and diverse effective strategies to promote healthy, satisfying, productive lives among formerly dependent individuals

For too many people, addiction is a **CHRONIC CONDITION WITH RECURRING ACUTE EPISODES**...this is why an improved system of care is essential.



# Falling through the Cracks!



In the absence of an integrated system of services that

- surrounds the individual,
- adapts to dynamic needs and
- provides continuity as recovery progresses...

there is a great likelihood that individuals literally ‘fall through the cracks’ of a **fragmented model of care** where services are provided by different agencies in different locations, agencies that may not communicate or that have different policies, cultures, admission requirements and/or reimbursement structures.





# **Dimensions of a Recovery-Oriented Approach**

# The Pathology Paradigm



- Response to chronic “drunkenness” starting in the late 1700’s
- Compulsive and destructive AOD use defined as a “disease of the mind and will”
- Reflects the assumption that knowledge of the source of the problem will lead to the eventual solution.
- Provides the underpinning for our extensive knowledge of the psycho-pharmacology and epidemiology of AOD Problems.

# The Intervention Paradigm



- Focused on attempts to resolve both at a personal and social level.
- Precipitated professionally directed treatment for AOD problems.
- Provides knowledge of what individuals look like prior to being admitted to treatment.
- Has allowed the majority of people who achieve sustained recovery do so after participating in treatment.
- Severe AOD Problems require 3-4 acute treatment episodes

# Advocacy Vision vs. Reality

Vision 1963-1970

Reality 2014

*Recovery*

*Treatment*

*Treatment*

*Recovery*

# The Recovery Paradigm

- Returning the focus from treatment to long term recovery.
- Shift of focus from addiction to recovery
- Shifting the fields energy and slogans from:
  - The nature of the problem – “addiction is a disease”
  - The effectiveness of interventions – “treatment works”
  - To the living proof of a permanent solution to AOD problems – “recovery is a reality”
- Examples: Faith-based recovery support structures; recovery employment co-ops; Wellbriety Movement

With Respect to Substance Use Disorders, How Would You Define:

- Successful Treatment
- Abstinence
- Recovery



# RECOVERY

**“Recovery is a process of change whereby individuals improve their health and wellness, to live a self-directed life, and strive to reach their full potential.”**

- *SAMHSA/CSAT 2011*

# Principles

person-driven

addresses  
**respect**

**trauma**

Emerges from  
**HOLISTIC peers**

**FAMILY**

culturally-based

**supported**

**HOPE**

Many  
pathways



# Guiding Principles of Recovery



- Recovery is person-driven
- Recovery occurs via many pathways
- Recovery is holistic
- Recovery is supported by peers and allies
- Recovery is supported through relationships and social networks
- Recovery is culturally based and influenced
- Recovery is supported by addressing trauma
- Recovery involves individual, family and community strengths and responsibilities
- Recovery is based on respect
- Recovery emerges from hope

# Recovery-Oriented Approach



A recovery-oriented systems approach supports person-centered and self-directed approaches to care that build on the strengths and resilience of individuals, families, and communities to take responsibility for their sustained health, wellness, and recovery from alcohol and drug problems.

(SAMHSA, 2010)

# Recovery-Oriented Systems of Care



- Macro-system Organizing Philosophy
  - “Recovery-oriented systems of care” (ROSC) are networks of formal and informal services developed and mobilized to support long-term recovery for individuals, families and communities impacted by severe substance use disorders.
    - ✦ ROSC influences the creation of values and policies in the larger cultural and policy environment that are supportive of these recovery processes.

# What is a ROSC?



## **A ROSC is NOT:**

- A model or new initiative
- Primarily focused on the integration of recovery support services
- Dependent on new dollars for development
- A group of providers that increase their collaboration to improve coordination
- An infusion of evidence based practices

# What is a ROSC?



## A ROSC:

- Is a value-driven, APPROACH to structuring behavioral health systems and a network of services and supports
- Bridges labels, taxonomies and philosophies
- Focuses on returning people to “Life in the Community”
- Is Comprehensive and holistic
- Focuses on essentials (jobs, housing, child and family)
- Is a framework to guide systems change

# What is a ROSC?



## A ROSC Integrates strategies to:

- Prevent the development of new substance use disorders and related health problems such as HIV/AIDS
- Reduce the harm caused by addiction
- Help individuals transition from brief experiments in recovery initiation to sustained recovery maintenance
- Uses medication assisted treatment where appropriate
- Promotes good quality of life, community health and wellness for all

# Values Underlying a ROSC



**Person-centered**

**Self-directed**

**Strength-based**

**Participation of family  
members, caregivers,  
significant others, friends,  
community**



# Values Underlying a ROSC (Cont.)



- Individualized, comprehensive services and supports
- Community-based services and supports





# Core Components of a ROSC

- **Multiple stakeholder involvement**
- **Recovery community/family involvement**
- **Provider Involvement**
- **Collaborative decision-making**
- **Continuity of services and supports**
- **Service quality and responsiveness**



# Core Components of a ROSC



- **Continuity of services and supports**
- **Service quality and responsiveness**
- **Adequately and flexibly funded**
- **Driven by recovery outcomes**
  - **For the individual**
  - **For the system**

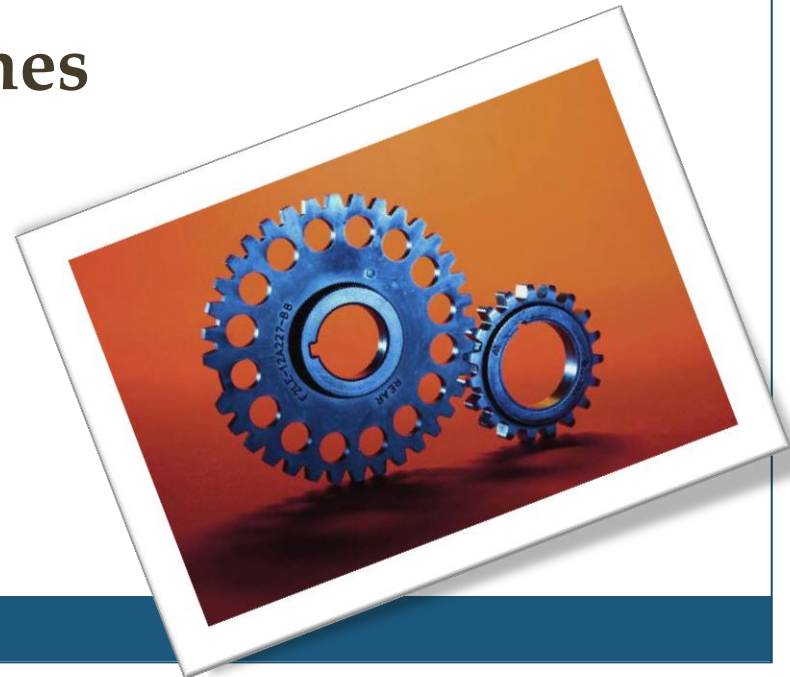

# RECOVERY DIMENSIONS

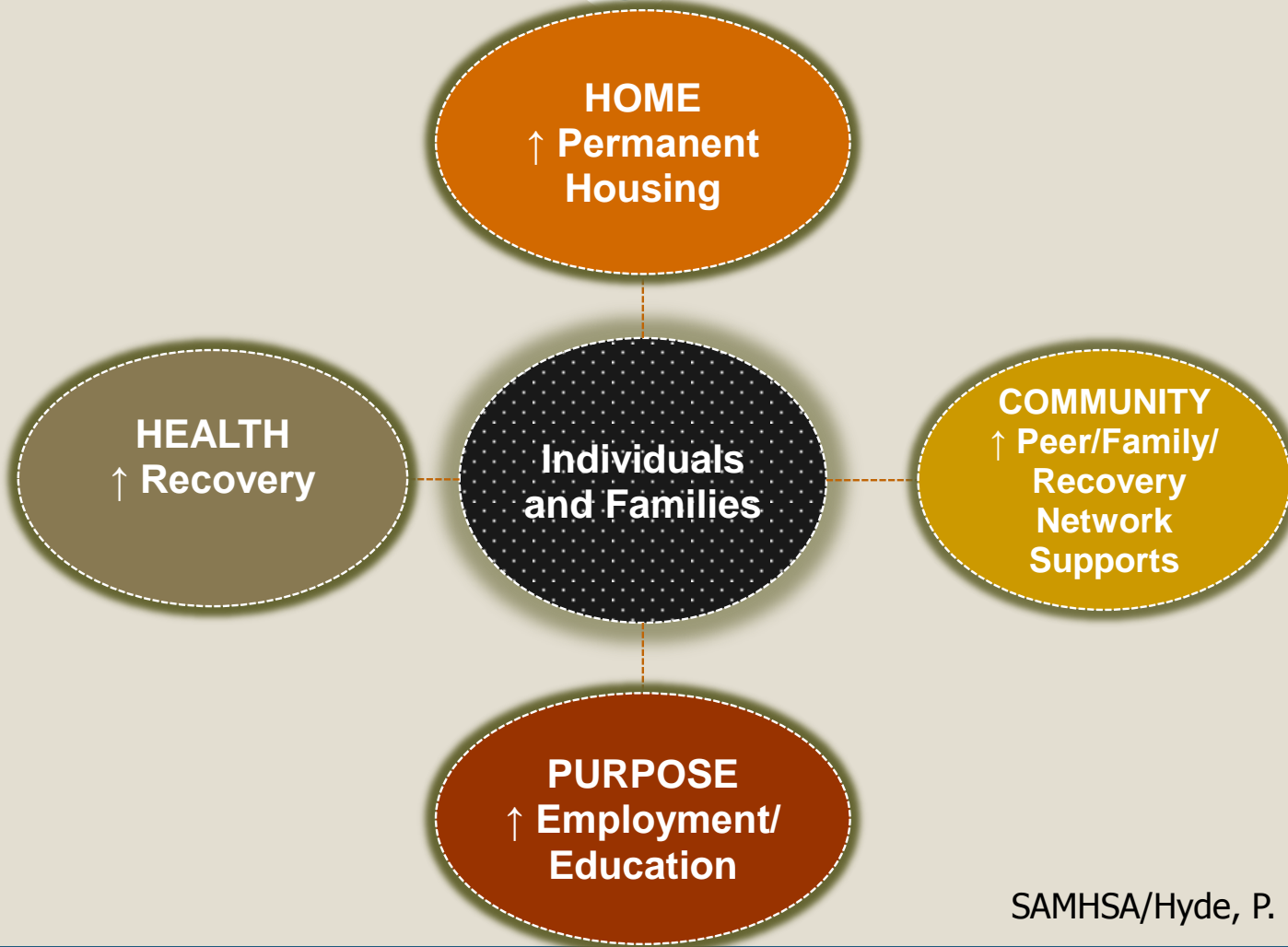

# Outcomes for the Individual



- Abstinence
- Education
- Employment
- Reduced criminal justice involvement
- Stability in housing
- Improved health
- Social connectedness
- Quality of life





**So What Would a Recovery  
Focus Look Like in a  
Treatment Center?**

# Guiding Principles of Recovery



- Recovery is person-driven
- Recovery occurs via many pathways
- Recovery is holistic
- Recovery is supported by peers and allies
- Recovery is supported through relationships and social networks
- Recovery is culturally based and influenced
- Recovery is supported by addressing trauma
- Recovery involves individual, family and community strengths and responsibilities
- Recovery is based on respect
- Recovery emerges from hope

“Man can live about forty days without food, about three day without water, about eight minutes without air, but only for one second without hope”

Anonymous

# A Recovery Focus Would Be:



- Person Centered
- Strength Based
- Meet the client where they are at when they walk in the door
- Services would be Trauma Informed
- Services would be culturally appropriate
- Counselor / Case Manager would be an ally not an adversary
- Would focus on supporting the person's recovery within their community.



# Person Centered Treatment



- Carl Rogers
- Core Concepts
  - Congruence
    - ✦ Self Concept
    - ✦ Ideal Self
    - ✦ Real Self
  - Unconditional Positive Regard
    - ✦ Non-judgmental

# Person Centered Treatment



- Core Concepts
  - Empathetic Understanding
    - ✦ Motivational Interviewing / Enhancement
  - Self Actualization
    - ✦ Every individual has the resources for personal development and growth
    - ✦ The role of the counselor is to provide the favorable conditions for that to occur

# Four Factors of Lasting Change

- **Expectancy**  
Expectancy equates to Hope; Hope on the part of both the client and the counselor.
- **Techniques**  
Counseling strategies, evidence based practices.
- **Extra-therapeutic** That which the client brings into treatment. Intrinsic and extrinsic motivation.
- **Therapeutic Relationship**  
The relationship between the client counselor

# Therapeutic Relationship



Counselors assist the natural healing process of a client. In the therapeutic alliance the counselor has to believe in this process. There are endless paths to personal change. We have to help the client find the most effective path for them.

# Therapeutic Collaboration

Therapeutic collaboration means mutual trust, mutual respect, and mutual dialogue that leads to agreed upon goals, objectives and solutions. Solutions to problems need to pass through the gender and cultural experiences of the client. As the client feels understood and validated, they begin to trust. As they begin to trust they begin to move

Change occurs.....

# Predicting Positive Treatment Outcomes

“Common therapeutic factors are the most robust predictors of client engagement, retention and outcome. The therapist behaviors that are common across most therapies consist of relationship variables such as warmth, empathy, acceptance, and encouragement of risk taking.”

*The Heart and Soul of Change* (Hubble, Duncan and Miller, 2010)

# Client Centered Treatment Individualized Service Plan

“If counselors take alliance, engagement and self-change seriously, their task is to join with clients to help them get what they want, not what the counselor thinks they need. For instance, clients may want to stay out of jail, keep their job or partner, get their children back, find housing, or get people to leave them alone.”

*The Heart and Soul of Change*, (Hubble, Duncan and Miller, 2010)

**OBJECT**

**RECIPIENT**

**RESOURCE**



# OBJECTS



Clients viewed as “objects”: The basis for this attitude is that one person or group “knows what’s best” for another person or group. The person being viewed as an object usually knows it.

# Recipients



Clients viewed as “recipients”:  
The first person or group still believes they know what is best for the other, but they “give” the other the opportunity to participate in decision-making because it will be “good” for the other person or group.

# Resources



Client viewed as resources: Here there is an attitude of respect by the first person or group toward what the other person or group can do. This attitude and the behaviors that follow it can be closely associated with two matters of great concern to ROSC: Self – Esteem and Productivity

I've learned that people  
Will forget what you  
said, people will forget  
what you did but people  
will never forget how  
you made them feel.

Maya Angelou



# **RECOVERY FRAMEWORKS**

# Medical Conditions



- Affect specific organs or parts of the body
- Have identifiable causes
- Have identifiable signs and symptoms
- Are either acute or chronic

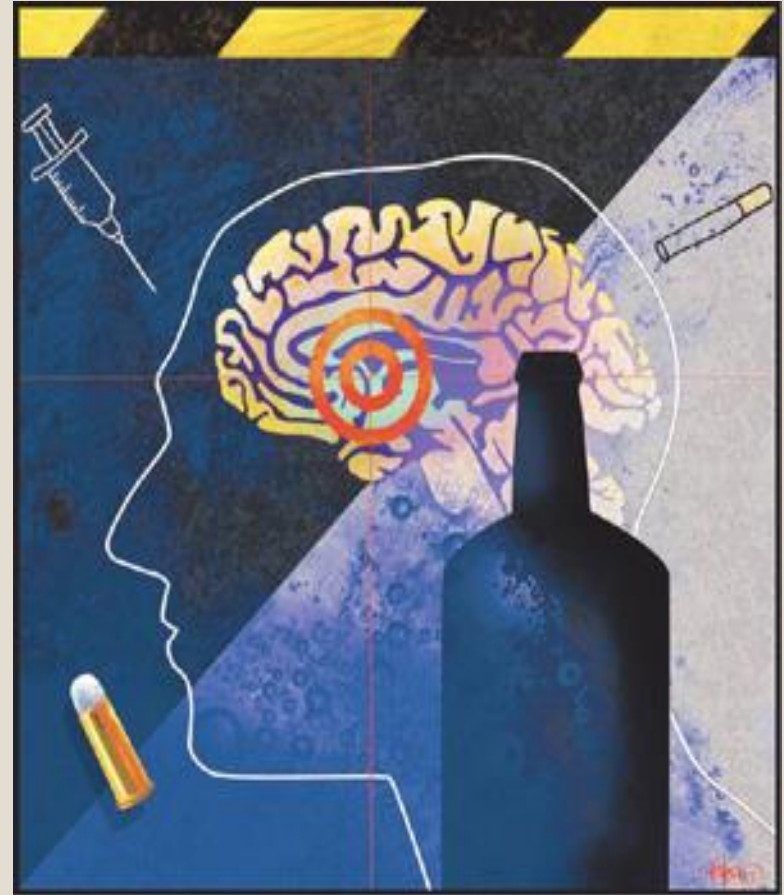

# Acute vs. Chronic

- An “Acute” Condition has:
  - Rapid onset
  - Short course
  - May be severe

- A “Chronic” Condition has:
  - Gradual onset
  - Lifetime course
  - May have “acute” episodes

# Types of Chronic Diseases



- Hypertension
- Diabetes
- Asthma



# The Acute Care Model



- Encapsulated set of service activities (assess, admit, treat, discharge, termination of service relationship).
- Professional expert drives the process.
- Services transpire over a short (and ever-shorter) period of time.
- Individual/family/community is given impression at discharge (“graduation”) that recovery is now self-sustainable without ongoing professional assistance.

# The Chronic Care Model



- Initial triage and stabilization, support services are varied and open ended most concentrated early on.
- Professionals serve as consultants. Goal is for course of treatment to be patient driven to achieve highest level of adherence.
- Services are open ended, routine follow-up the norm.
- Individual/family/community educated on the “process” nature of “treatment”. Goal is to facilitate improved quality of life and wellness for the patient in whatever way works best for the patient.

# Limitations of an Acute Care Model



- Has addiction treatment matched an acute care or chronic care style of intervention?

# 8 Key Performance Arenas Linked to Long-term Recovery Outcomes



- 1. ATTRACTION, ACCESS & EARLY ENGAGEMENT**
- 2. SCREENING, ASSESSMENT & PLACEMENT**
- 3. COMPOSITION OF THE SERVICE TEAM**
- 4. SERVICE RELATIONSHIP**
- 5. SERVICE DOSE, SCOPE & QUALITY**

# 8 Key Performance Arenas Linked to Long-term Recovery Outcomes



6. LOCUS OF SERVICE DELIVERY
7. ASSERTIVE LINKAGE TO COMMUNITIES OF RECOVERY
8. POST-TREATMENT MONITORING, SUPPORT AND EARLY RE-INTERVENTION

# 1. Attraction, Access & Early Engagement



## Acute Care Limitations

- 10% & 25% data; late stage and under coercion; waiting list drop-out data; attrition data (more than 50% will not complete)

## Recovery Management Directions

- Assertive community education & outreach
- Assertive waiting list management
- Lowered threshold of engagement; rethinking motivation; institutional outreach
- Changes in administrative discharge policies

## 2. Screening, Assessment & Placement



Acute Care assessment is categorical, pathology-focused, professionally-driven, an intake function & focused on individual; placement based on problem severity.

Recovery Management assessment is global, strengths-based, client focused (rapid transition to recovery plans), continual and encompasses the individual, family and recovery environment; recovery capital factored into placement decisions.

# 3. Composition of the Service Team



Acute Care model uses disease rhetoric but few medical personnel; recovery rhetoric but decreasing involvement of recovering people.

Recovery Management expands role of medical (including primary care physicians) and other allied professionals, recovering people (P-BRSS) and culturally indigenous healers. Also emphasizes reinvestment in volunteer and alumni programs.



## 4. Service Relationship



Acute Care: Dominator model; emphasis on professional authority; great power discrepancy; role of client is one of compliance.

Recovery Management: Sustained recovery partnership (long-term consultation) model; emphasis on prolonged continuity of contact; client as co-leader; philosophy of choice; greater use of personal/professional self; contrasting ethical guidelines.

## 5. Service Dose, Scope & Quality



Acute Care model has become ever briefer, narrower via reimbursable services & continues to incorporate methods lacking scientific support.

Recovery Management model emphasis on importance of dose (NIDA principles—90 days), role of ancillary services and weeding out practices that are not linked to recovery outcomes or that may produce inadvertent injury.

## 6. Locus of Service Delivery



Acute Care model locus is the institution: How do we get the individual into treatment—get them from their world to our world?

- \* Problem of transfer of learning

Recovery Management model emphasizes the ecology of long-term recovery: “How do we nest recovery in the natural environment of this individual or create an alternative recovery-conducive environment?”

- \* Healing forest metaphor (Coyhis)

- \* Concept of “community recovery”

## 7. Assertive Linkage to Communities of Recovery



Acute Care Model: Passive linkage, low affiliation and high early attrition, single pathway model of recovery

Recovery Management model: Assertive linkage, multiple pathway model of recovery, linkage beyond recovery mutual aid groups; active relationship with local service committees, involved in recovery community resource development

## 8. Post-treatment Monitoring, Support and, if needed, Early Re- intervention



- 50-80-90 rule: More than 50% of clients discharged from Tx will return to some use in the next year—80% of those will do so in first 90 days after discharge.
- 15-25 rule: The stability point of recovery (risk of future lifetime relapse drops below 15%) isn't reached until 4-5 years for alcohol dependence; 25% of opioid dependent persons who achieve five years of abstinence will later resume narcotic addiction.

## 8. Post-treatment Monitoring, Support and, if needed, Early Re-intervention

- 25-35% of clients who complete addiction treatment will be re-admitted to treatment within one year, 50% within 2-5 years (Hubbard, et al, 1989; Simpson, et al, 2002).
- An Acute Revolving Door: Of those admitted to the U.S. public treatment system in 2003, 64% were re-entering treatment--23% accessing treatment the 2nd time, 22% for the 3<sup>rd</sup> or 4<sup>th</sup>, and 19% for 5 or more times (OAS/SAMHSA, 2005).

# 8. Acute Care Model: “Aftercare” as an Afterthought



- Post-discharge continuing care can enhance recovery outcomes (Johnson & Herringer, 1993; Godley, et al, 2001; Dennis, et al, 2003).
- But only 1 in 5 (McKay, 2001) to 1 in 10 (OAS, SAMHSA, 2005) adult clients receive such care (McKay, 2001) and only 36% of adolescents receive any continuing care (Godley,et al, 2001)

# 8. Recovery Management Model: Assertive Approaches to Continuing Care



- POST-TREATMENT MONITORING & SUPPORT (RECOVERY CHECKUPS)
- STAGE-APPROPRIATE RECOVERY EDUCATION & COACHING
- ASSERTIVE/CONTINUED LINKAGE TO RECOVERY RESOURCES
- EARLY RE-INTERVENTION & RE-LINKAGE TO TREATMENT AND RECOVERY SUPPORT RESOURCES
- RECOVERY COMMUNITY BUILDING



# III. Recovery Management



- Microsystem
- Organizing Philosophy
  - RM is a philosophy of organizing addiction treatment and recovery support services to enhance:

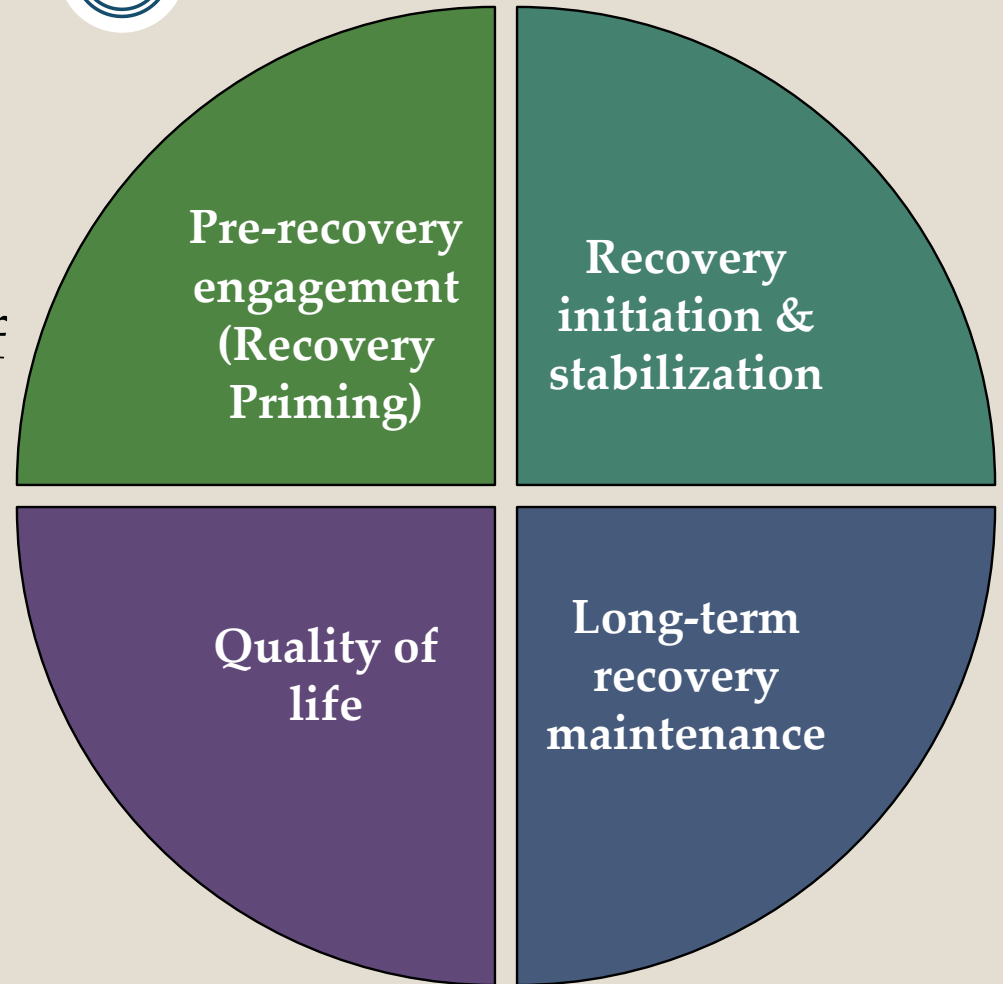

# 1. Recovery Priming: RM Model Strategies



Anti-stigma campaigns

# 1. Recovery Priming: RM Model Strategies



Anti-stigma campaigns

Assertive models of community outreach

# THPWC Engagement, EMS Transports and ED Visits

## A study of one client

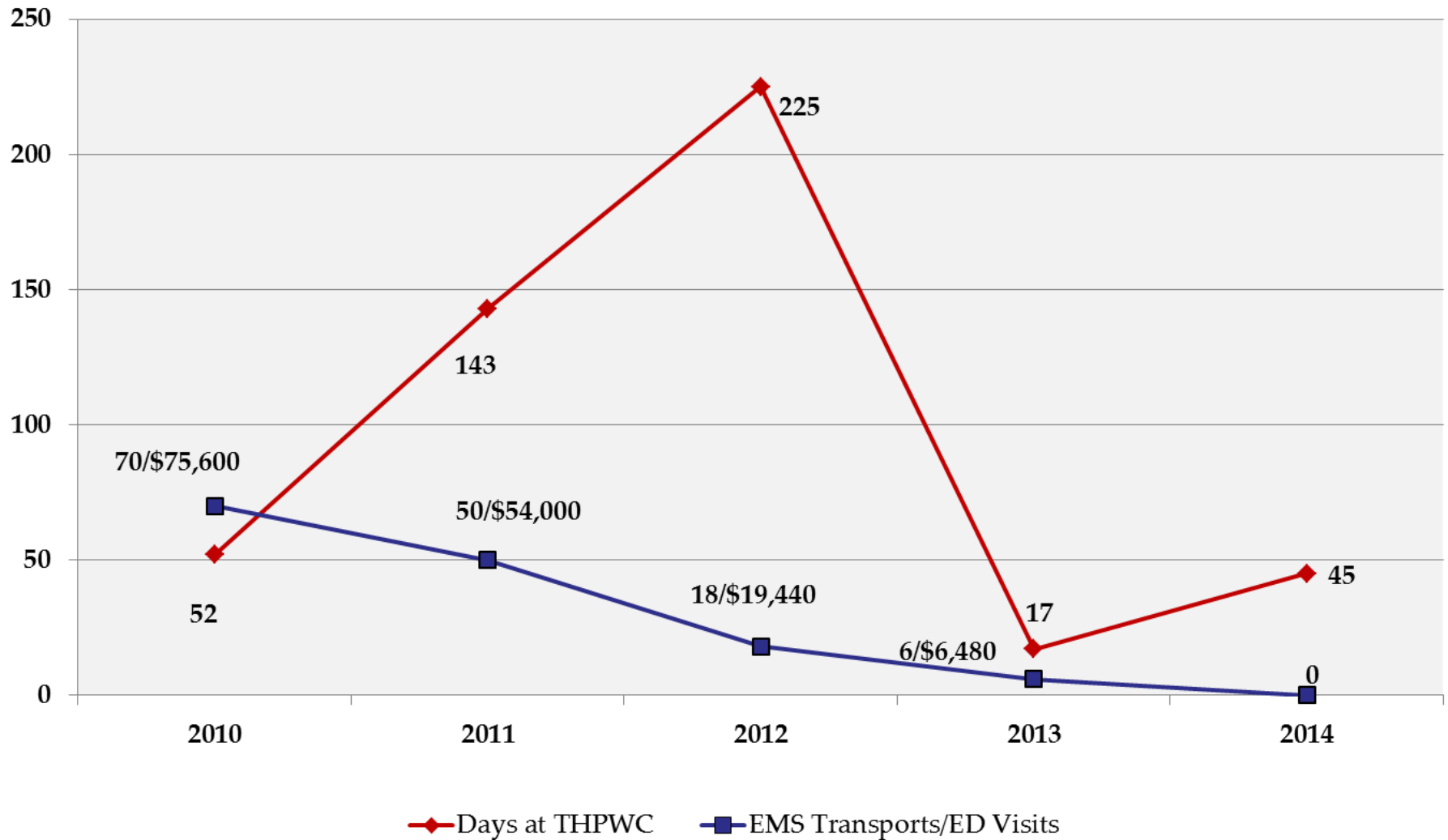

# 1. Recovery Priming: RM Model Strategies



Anti-stigma campaigns

Assertive models of community outreach

Recovery presence in communities

# 1. Recovery Priming: RM Model Strategies



- Recovery presence in communities
  - Recovery Community Centers
  - Recovery Month Events

**Recovery Management (RM)** is a philosophical framework for organizing addiction treatment and recovery support services across the stages of:



**pre-recovery identification and engagement**



**recovery initiation and stabilization (treatment), and**



**long-term recovery maintenance**



**With the ultimate goal of quality of life enhancement for individuals and families**

# 1. Recovery Priming: RM Model Strategies



Anti-stigma campaigns

Assertive models of community outreach

Recovery presence in communities

Terminology



# Language of Recovery

Current Terminology	Alternative Terminology
Treatment is the goal; Treatment is the only way into Recovery	Treatment is an opportunity for initiation into recovery (one of multiple pathways into recovery)
Substance Abuse	Substance Use Disorder/Substance Misuse
Drug of Choice / Abuse	Drug of Use
Denial	Ambivalence
Relapse Prevention	Recovery Management
Pathology Based Assessment	Strength / Asset Based Assessment
Focus is on total abstinence from all illicit and non-prescribed substances the CLINICIAN identifies	Focus on the drug CLIENT feels is creating the problems
A Drug is a Drug is a Drug	Each illicit substance has unique interactions with the brain; medication if available is appropriate.
Relapse	Recurrence/Return to Use
Relapse is part of Recovery	Recurrence/Return to Use may occur as part of the disease
Clean / Sober	Drug Free / Free from illicit and non-prescribed medications
Self Help Group	Mutual Aid Group
Untreated Addict/Alcoholic	Individual not yet in Recovery

# Recovery Initiation



- **Peer – assisted recovery**
  - Mutual aid groups – AA, NA, CA, MA, etc.
- **Faith – based recovery**
  - Celebrate Recovery, Teen Challenge, Reformer’ s Unanimous, Local Recovery Ministries
- **Internet – assisted recovery**
  - In The Rooms, On – line counseling, Life Recovery Program, EGetGoing, Enterhealth, MyRecoveryNetwork, Sober24
- **Secular recovery**
  - Rational Recovery, Save Our Selves, SMART Recovery

# Substance Abuse



- Substance Abuse
  - The concept of “abuse”
  - Behavioral / Judgmental / Stigmatizing term (as in “Domestic or Child Abuse”)
- DSM V
  - Substance Use Disorder
- Misuse
- Addiction vs. Dependence

# Substance Abuse



- Kelly & Westerhoff (2010) study
  - Case studies with “substance abuser” and “person with substance use disorder.”
- Those receiving the “abuser” paragraph were significantly more likely:
  - To agree that Mr. Williams should be punished and
  - To blame Mr. Williams for his condition and failure to comply with the treatment protocol

# Drug of Choice / Abuse



- “Choice” is a behavioral not a medical term
- “Drug of Abuse”
- Drug of Use

# Denial vs. Ambivalence



“Intrinsic motivation for change arises in an accepting, empowering atmosphere that make it safe for the person to explore the possibly painful present in relation to what is wanted and valued. People often get stuck, not because they fail to appreciate the down side of their situation, but because they feel at least two ways about it.” (Miller and Rollnick, 2002)

# The language that we use



- They're not ready
- They don't want it bad enough
- They haven't hurt/lost enough
- They're too resistant
- They are in denial

# “Those people”



- Alcoholic
- Addict
- Drunk
- Old Wino
- Crack Head
- Junkie
- Needle Freak
- Benzo Queen
- Garbage Head

- Burn Out
- Pot Head
- Borderline

- And then there is  
“Chronic  
Relapser”

or

“Chronic Recidivist”



# Total Abstinence



- Current focus is on “total abstinence” from substances/behaviors CLINICIAN feels are problematic, regardless of what the client feels is problematic
- Viewing Substance Use Disorders as a chronic condition and behavior change in the context of a process.

# A Drug is a Drug is a Drug...



- Different cultures surrounding different drugs
- Stigmatizes individuals in Medication Assisted Recovery and individuals with Mental Disorders taking prescription medications.
- And then there is nicotine, caffeine and sugar?

# Relapse



- In no other chronic medical condition is a return to being symptomatic described a “relapsing”.
- Stigmatizing term
- Carries much emotional baggage
- A more medically accurate term would be “a recurrence” or “a return to use”. A less stigmatizing term would be a “setback”.

## 2. Recovery Initiation: RM Model Strategies



- Motivation for change no longer seen as sole responsibility of individual
  - “We’ll be here when you’re ready”
- Motivation is shared responsibility with the treatment team, family and community institutions (White, Boyle & Loveland, 2003)
- Motivation is not a pre-condition for treatment, but as an outcome of a service process
  - A strong therapeutic relationship can overcome low motivation for treatment and recovery (Ilgen, et al, 2006)

## 2. Recovery Initiation: RM Model Strategies



- Weak understanding of physical and cultural contexts in which people are attempting to initiate recovery
  - AC Model question: “How do we get the individual into treatment” --get them from their world to our world?
  - **RM question: “How do we nest recovery in the natural environment of this individual?”**

## 2. Recovery Initiation: RM Model Strategies



- What do we know about the physical and cultural contexts in which people are attempting to initiate recovery?

### 3. Recovery Maintenance: RM Model Strategies



- I'm sorry that we haven't done a better job supporting you.

### 3. Recovery Maintenance: RM Model Strategies



- The majority of people completing addiction treatment resume AOD use in the year following treatment (Wilbourne & Miller, 2002).
- Of those who consume alcohol and other drugs following discharge from addiction treatment, 80% do so within 90 days of discharge (Hubbard, Flynn, Craddock, & Fletcher, 2001).



### 3. Recovery Maintenance: RM Model Strategies



Post-treatment monitoring and support for all clients for up to 5 years

Responsibility for contact shifts from the client to the provider

Native American “healing forest metaphor” for recovery maintenance

Use of peer support/alumni

### 3. Recovery Maintenance: RM Model Strategies



- Examples from The Healing Place of Wake County
  - Telephone recovery support in 2014
    - ✦ 50 participants made over 2,000 phone calls to 109 participants who were re-engaging in recovery following a return to use
  - Letters to inmates in 2014
    - ✦ 1,532 letters were written to incarcerated former/potential participants by current participants

## 4. Enhance Quality of Life: RM Model Strategies



Enhanced quality of personal/family life

Extending recovery careers

Removing barriers to full citizenship

# Recovery Capital

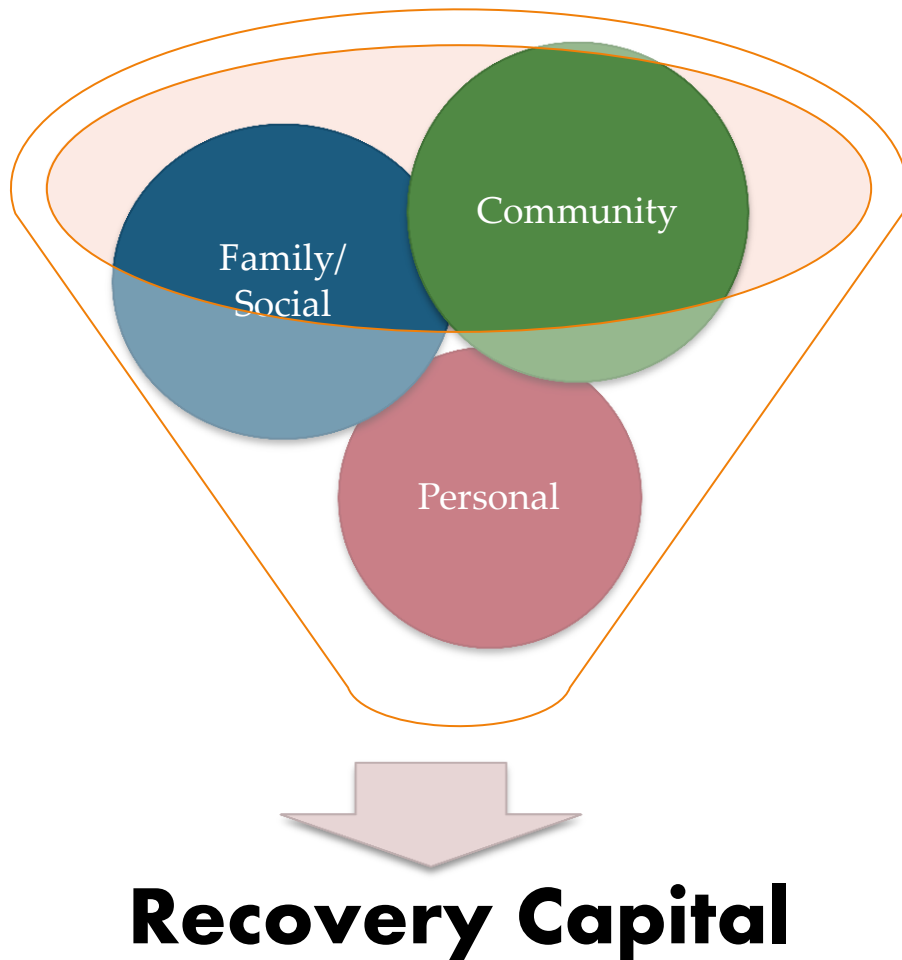

- *Recovery Capital (RC)* is the breadth and depth of internal and external resources that can be drawn upon to **initiate** and **sustain** recovery.
- There are three types of Recovery Capital that can be influenced by addictions professionals.

# Personal Recovery Capital



## **Physical recovery capital includes:**

- physical health
- financial assets
- health insurance
- safe and recovery-conducive shelter
- clothing, food, and
- access to transportation.

White and Cloud, 2008

# Personal Recovery Capital

## Human recovery capital includes:

- values
- knowledge
- educational/vocational skills and credentials
- problem solving capacities

- self-awareness, self-esteem, self-efficacy
- hopefulness/optimism
- perception of one's past/present/future
- sense of meaning and purpose in life, and
- interpersonal skills

White and Cloud, 2008

# Family/Social Recovery Capital



- Encompasses intimate relationships, family and kinship relationships, and social relationships that are supportive of recovery efforts
- Is indicated by:
  - the willingness of intimate partners and family members to participate in treatment
  - the presence of others in recovery within the family and social network
  - access to sober outlets for sobriety-based fellowship/leisure,
  - relational connections to conventional institutions

# Community Recovery Capital

Community recovery capital includes:

- active efforts to reduce addiction/recovery-related stigma
- visible and diverse local recovery role models
- a full continuum of addiction treatment resources
- recovery mutual aid resources that are accessible and diverse
- local recovery community support institutions
- cultural capital



# Importance of Recovery Capital



- Recovery capital, both its quantity and quality, plays a major role in determining the success or failure of natural and assisted recovery (Granfield & Cloud, 1996, 1999; Moos & Moos, 2007; Kaskutas, Bond, & Humphreys, 2002).
- Increases in recovery capital can spark *turning points* that end addiction careers; trigger recovery initiation; elevate coping abilities; and enhance quality of life in long-term recovery (Cloud & Granfield, 2004; Laudet, Morgan, & White, 2006).

White and Cloud, 2008

# Importance of Recovery Capital



- Such turning points, both as climactic transformations and incremental change processes, may require the accumulation of recovery capital across several years and multiple episodes of professional treatments (Dennis, Foss, & Scott, 2007).
- Elements of recovery capital vary in importance within particular stages of long-term recovery (Laudet & White, 2010).

# Peer Support Specialists

- **Peer Specialist** - a peer who has been trained and employed to offer peer support to people with behavioral health conditions in any of a variety of settings



# Values of Peer Support Services



- Provide a link between treatment and community systems
- Engage persons seeking recovery and facilitate entry into treatment as desired
- Provide social support services during treatment
- Provide a post-treatment safety net to sustain treatment gains
- Are very adaptable:
  - operating within diverse populations,
  - stages of recovery,
  - pathways to recovery,
  - service settings, and organizational contexts

# Goals of Peer Support



**Increase connection to treatment**

**Reduce obstacles to continued engagement in services and supports**

**Increase people's ability to sustain their recovery following treatment**

# Four Types of Recovery Support Services



## **Emotional:**

Demonstrations of empathy, care, concern

## **Informational:**

Assistance with knowledge, information, and skills

## **Instrumental:**

Concrete assistance in helping others get things done

## **Affiliational:**

Feeling connected to others, having a social group and/or community

# Where Do We Go From Here

- Based on what we now know, what is the role of Prevention in a recovery oriented system?
- What needs to happen to transition from the more traditional treatment model to a recovery-oriented model care?
- What strategies can we use to provide or broker recovery-oriented services?
- What are the roles of self-help groups, professional treatment, recovery peer specialists, and other emerging forms of recovery management?

# Making a Shift: Potential Obstacles

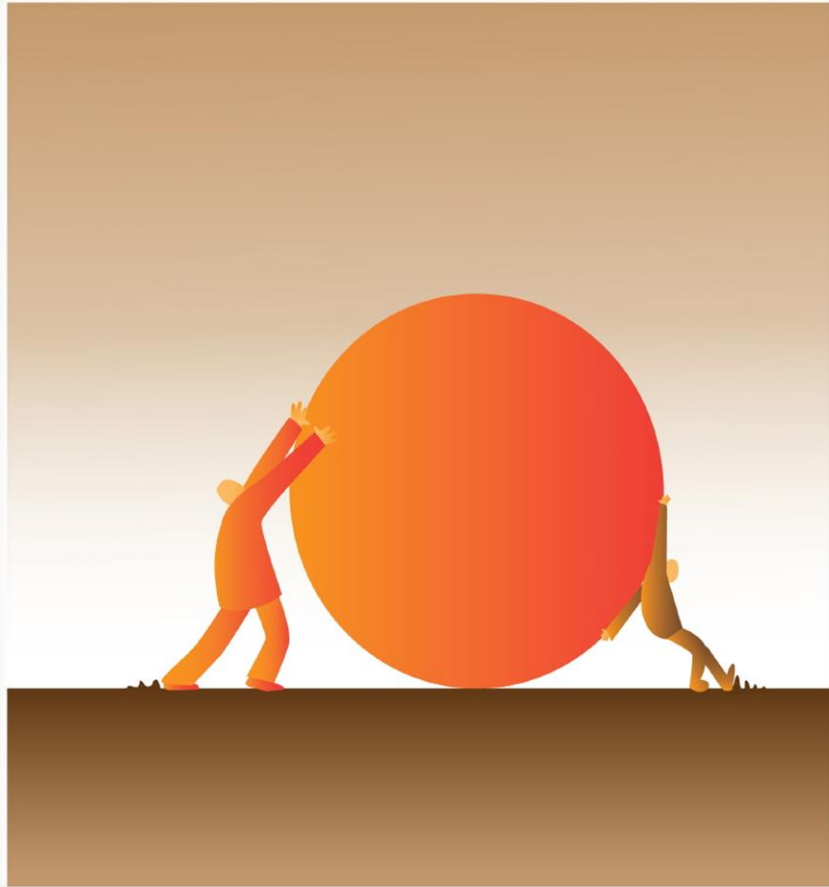

- Conceptual
- Personal/Professional
- Financial
- Technical
- Ethical
- Institutional



# To sum it all up.....



- By us changing our language we can start the process of the general public changing their language and perception
- We need to bring unequivocal messages of hope that the problems of substance use disorders can be resolved
- The focus needs to be on the solutions that recovery brings
  - The reality of recovery
  - The diversity of patterns of recovery
  - The variety of methods used to achieve recovery

# Resources

1. Addiction Technology Transfer Centers (ATTC)
  - a. Great Lakes – ROSC Webinar Series , ROSC Monograph Series (go to [www.attcnetwork.org](http://www.attcnetwork.org) under Regional Centers, go to “Great Lakes”)
  - b. Northeast /IRETA – “Linking Addiction Treatment and Communities of Recovery” (go to [www.attcnetwork.org](http://www.attcnetwork.org) under Regional Centers, go to “Northeast”)
2. [www.bhrm.org](http://www.bhrm.org) Papers and Clinical Guidelines
3. “Transformation Practice Guidelines”  
[www.dbhids.org](http://www.dbhids.org)
4. [www.williamwhitepapers.com/rm\\_rosc\\_library](http://www.williamwhitepapers.com/rm_rosc_library)
5. [www.naadac.org/webinars](http://www.naadac.org/webinars)
6. edjohnson@msm.edu